

Article number: 0107062

Description: Retaining ring AK 45 DIN 983

Measures

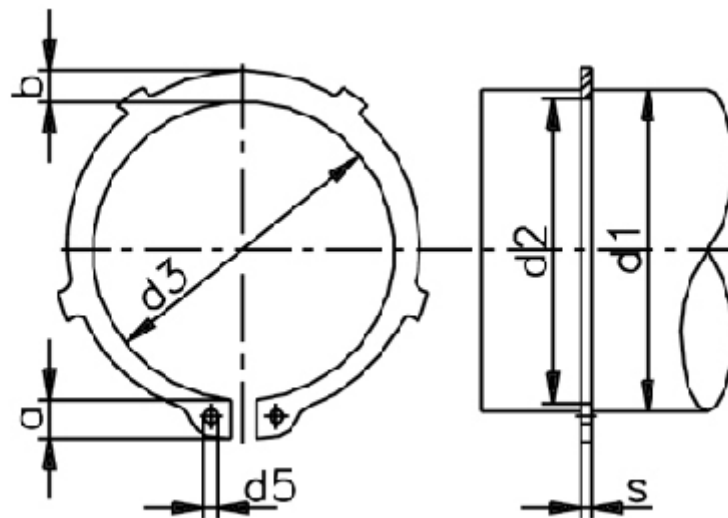

a max	= 7.2	FN kN	= 28.60	Number of serrations	= 6
AN mm ²	= 172.0	FRg kN	= 9.3	s	= 1.75
b	= 4.6	FR kN	= 49.0	t	= 1.25
d1	= 45	g	= 2.0	tol	= -0.25
d2	= 42.5	K kN-mm	= 91.0	tol	= -0.06
d3	= 41.5	m min	= 1.85	tol	= +0,39-0,90
d5 min	= 2.5	n abl x 1000	= 11	Tong	= ZGA-3
Description	= AK 45	Nominal drive	= 3.8	Weight kg/1000	= 8.50